

FANTURA INLET

> -35°C

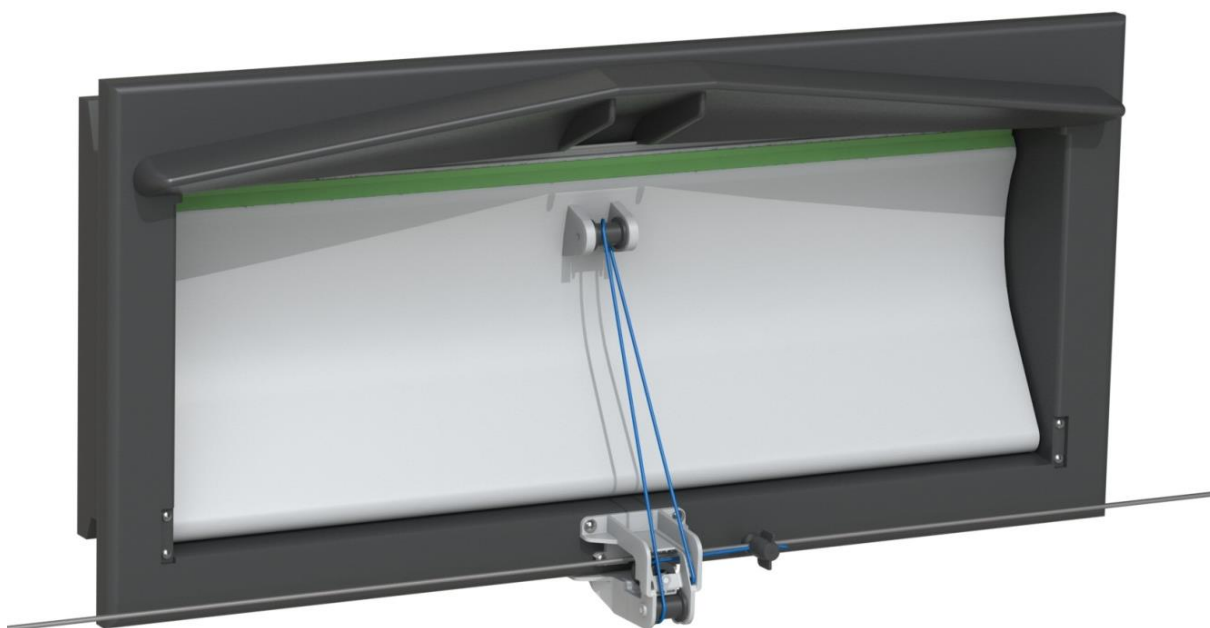

GB MANUAL

NL HANDLEIDING

DE ANLEITUNG

FR NOTICE

ES MANUAL

RU РУКОВОДСТВО

180111
Art. Nr. 5911924

Fancom[®]
forward thinking



1x (A)

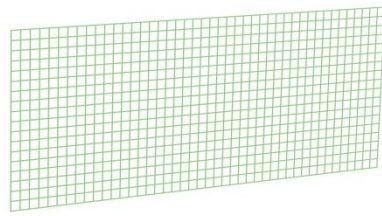

1x (B)



1x (C)



1x (D)



1x (E)



4x (F)



4x (G)



8x (H)



8x (I)

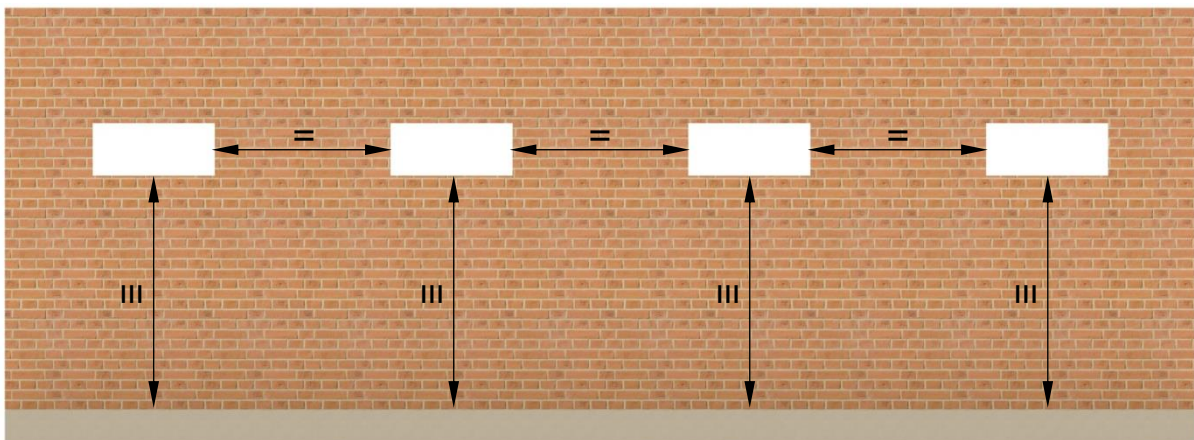
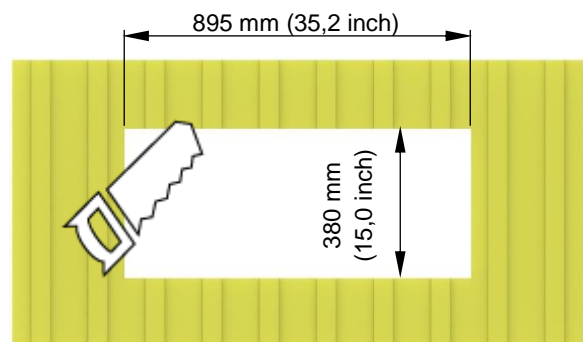
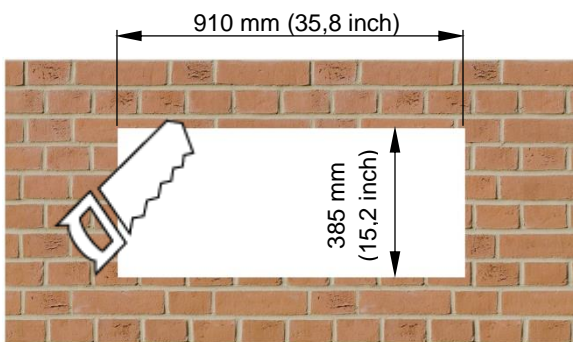
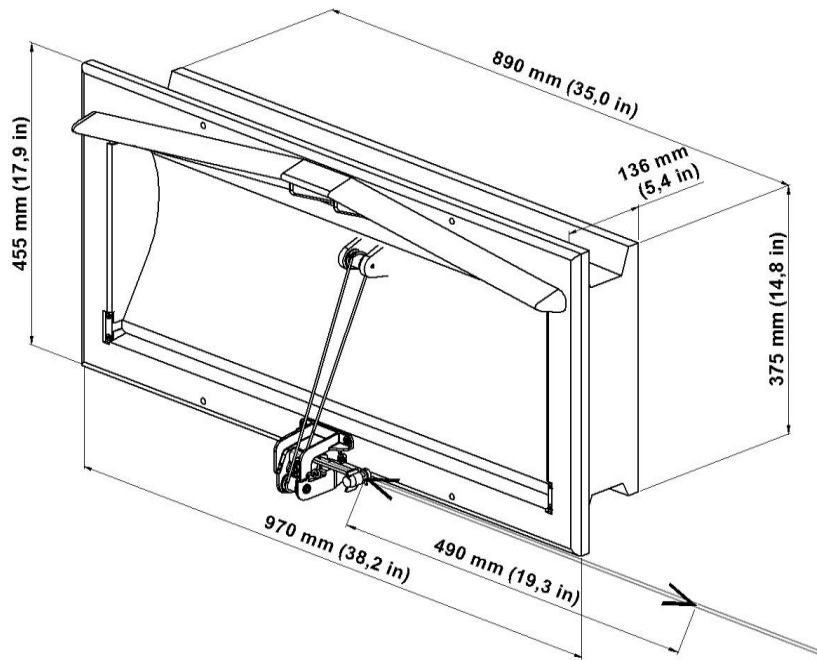



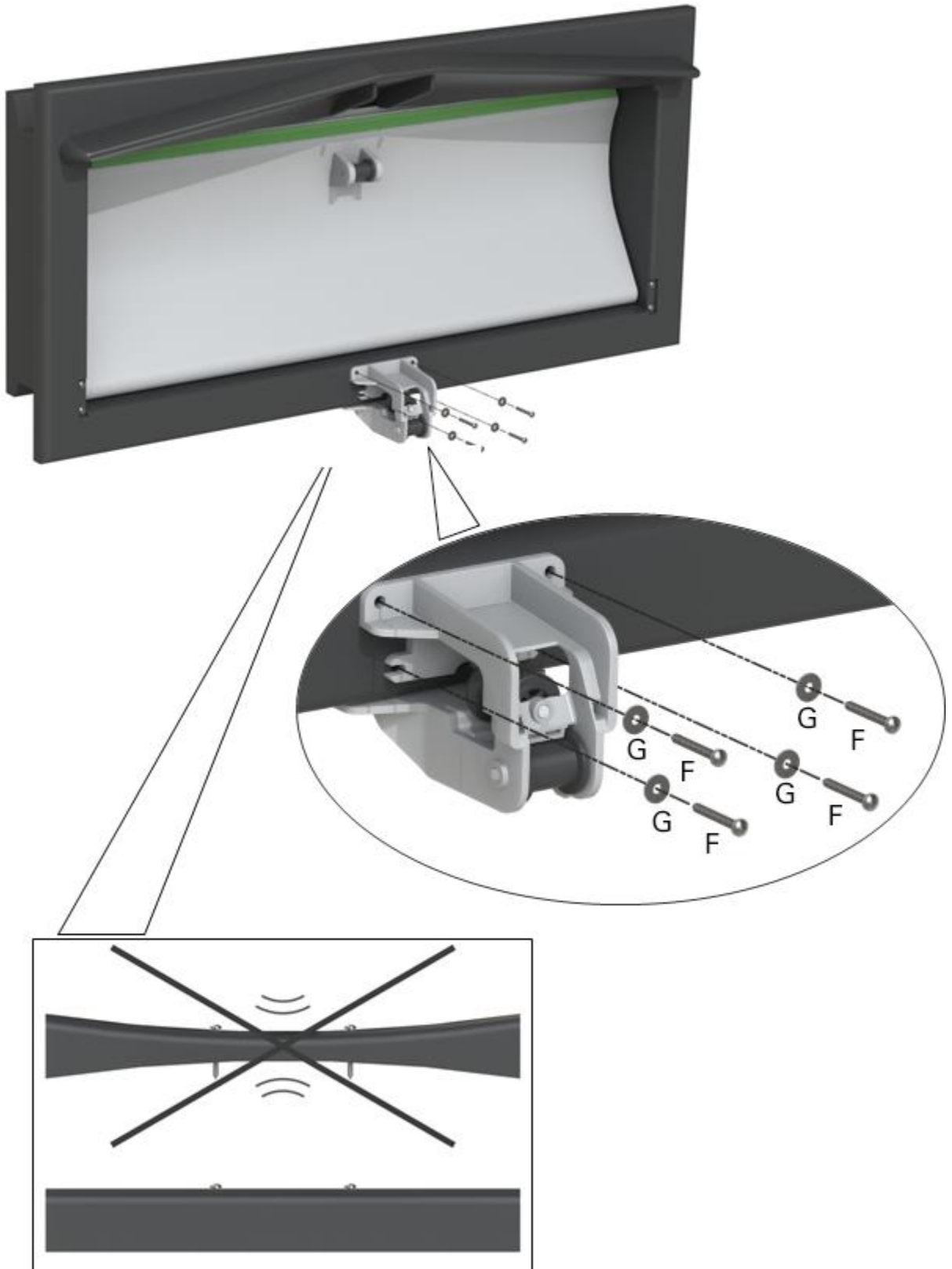

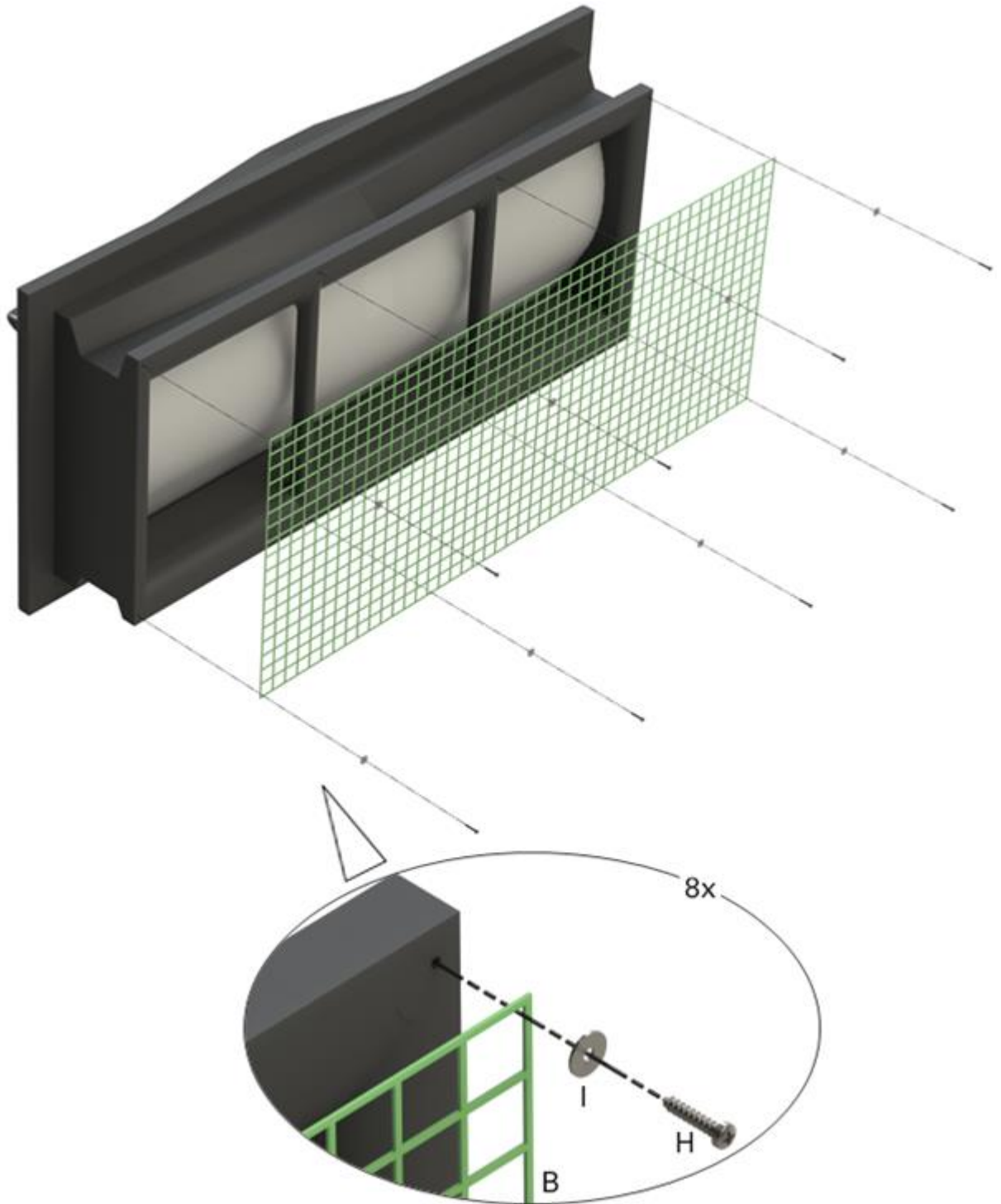















GB

	Make sure the air inlet will not deform when mounting.
	Do not use expansion foam, this could deform the air inlet with malfunctioning as result!
	High pressure cleaning: Maximum pressure: 100-120 bar Minimum spray distance: 40 cm (15,7 inch)
	Remove any dirt behind the seals regularly so that the seals can move freely whenever the valve changes position. Pay particular attention to the lower seal immediately behind the valve.
	Maximum stroke 1500 Wall Inlet: 320 mm (12,6 inch) Maximum stroke 3500 Wall Inlet and Fantura >-5°C: 440 mm (17,3 inch)





NL

	Zorg ervoor dat de luchtinlaat tijdens het monteren niet vervormt.
	Gebruik geen expansieschuim, want dat kan de luchtinlaat vervormen, zodat die niet meer goed werkt!
	Hogedrukreiniging: Maximum druk: 100-120 bar Minimale spuitafstand: 40 cm (15,7 inch)
	Verwijder regelmatig vuil achter de afdichting zodat de afdichtingen vrij kunnen bewegen wanneer de klep van positie verandert. Let vooral op de onderste afdichting, direct achter de klep.
	Maximaal bereik muurinlaat 1500: 320 mm (12,6 inch) Maximaal bereik muurinlaat 3500 en Fantura >-5 °C: 440 mm (17,3 inch)





DE

	Achten Sie darauf, dass der Lufteinlass bei der Montage nicht deformiert wird.
	Verwenden Sie keinen Montageschaum, weil dies zu einer Deformierung des Lufteinlasses und dadurch zu Fehlfunktionen führen könnte!
	Hochdruckreinigung: Maximaler Druck: 100-120 bar Mindestspritzabstand: 40 cm (15,7 Zoll)
	Entfernen Sie regelmäßig Schmutz hinter den Dichtungen, damit sich die Dichtungen bei Positionsänderungen des Ventils frei bewegen können. Achten Sie besonders auf die untere Dichtung direkt hinter dem Ventil.
	Maximalhub 1500 Wandeinlass: 320 mm (12,6 Zoll) Maximalhub 3500 Wandeinlass und Fantura >-5°C: 440 mm (17,3 Zoll)





FR

	Assurez-vous que l'entrée d'air ne se déforme pas.	
	N'utilisez pas de la mousse expansive, car cela déformerait l'entrée d'air et provoquerait un dysfonctionnement.	
	Nettoyage haute pression :	
	Pression maximum :	100-120 bars
	Distance de vaporisation minimum :	40 cm (15,7 pouces)
	Nettoyez régulièrement derrière les joints afin qu'ils puissent bouger librement lorsque le couvercle change de position. Accordez un soin particulier au joint qui se trouve directement en dessous.	
	Course maximale 1500 prise murale :	320 mm (12,6 pouces)
	Course maximale 3500 prise murale et Fantura > -5 °C :	440 mm (17,3 pouces)

ES

	Asegúrese de que la válvula de admisión de aire no se deforme durante el montaje.	
	No use espuma de expansión, que puede deformar la válvula de admisión de aire y provocar averías.	
	Limpieza a alta presión:	
	Presión máxima:	100-120 bar
	Distancia mínima de rociado:	40 cm (15,7 pulgadas)
	Elimine con regularidad la suciedad de la parte posterior de las juntas para que estas puedan moverse con facilidad cuando la válvula cambie de posición. Preste especial atención a la junta inferior situada inmediatamente detrás de la válvula.	
	Carrera máxima de entrada mural 1500:	320 mm (12,6 pulgadas)
	Carrera máxima de entrada mural 3500 y Fantura >-5°C:	440 mm (17,3 pulgadas)

RU

	Будьте осторожны, чтобы не деформировать воздухозаборник в процессе монтажа.	
	Не применяйте монтажную пену! Пена расширится и деформирует воздухозаборник, что выведет его из строя.	
	Чистка под высоким давлением:	
	Максимальное давление:	100–120 бар
	Минимальное расстояние для распыления:	40 см (15,7 дюйма)
	Регулярно удаляйте грязь за уплотнениями, чтобы они могли свободно двигаться при изменении положения клапана. Особое внимание обращайте на нижнее уплотнение сразу за клапаном.	
	Настенный входной клапан, не более 1500 ходов:	320 мм (12,6 дюйма)
	Настенный входной клапан и Fantura, не более 3500 ходов, >-5 °C:	440 мм (17,3 дюйма)

